



Codice	1723 RNF
Code	



Scheda tecnica avvolgicavo serie 1700 tipo 1
Technical cable reel table series 1700 type 1

CARATTERISTICHE GENERALI

- dente di arresto viene fornito disinserito, ed è facilmente inseribile dall'utente prima dell'installazione
- Grado di protezione IP 65
- Gli avvolgitori da noi forniti completi di cavo, sono corredati di calza fissa cavo idonea al cavo installato
- Fornito con spezzone di ingresso m 2,5
- Temperatura ambiente di utilizzo: -5°C/+40°C
- Tensione di isolamento collettore 2,5 Kv

GENERAL FEATURES

- delivered with disconnected ratchet, and it can be easily inserted by user **before** the installation
- Protection degree IP 65**
- The reels delivered by us with cable are equipped with cable fastening socks suitable to the installed cable
- Delivered with 2,5 m incoming cable
- Working temperature: -5°C / +40°C
- Collector insulating power 2,5 Kv

Disponibile modello fornito SENZA cavo, aggiungere "SC" al codice







Available also without cable, add "SC" to the article number

Per ulteriori informazioni contattare il nostro ufficio tecnico

For further information please contact our technical department



Codice	1723 RNF
Code	

	Numero conduttori Number of cores		4
	Sezione Cross section	mm ²	2,5
	Tipo di cavo Cable type		H07 RN-F
	Portata collettore Slipping capacity	A	32
	Potenza max Max power	kW	6,0
	Potenza max Max power	kW	8,5
	Diametro cavo Cable diameter	mm	13
	Peso cavo Cable weight	(g/m)	205
	Lunghezza Length	m	39 + 2



Avvolgicavo / Cable reel

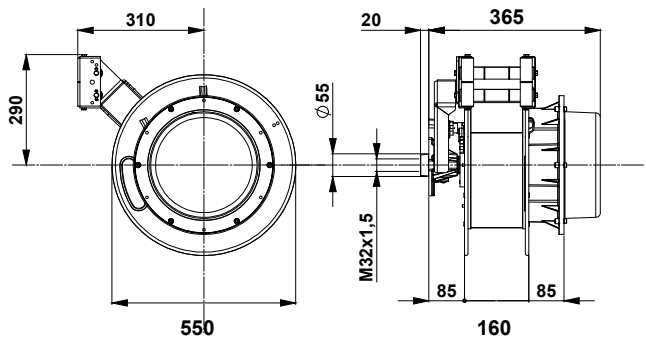

Dimensioni d'ingombro / Overall dimension

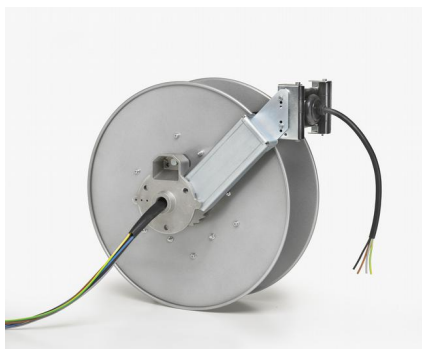

Ingresso cavo / Cable input

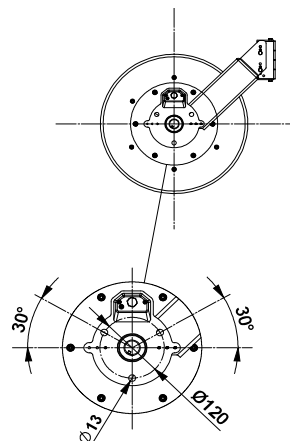

Dimensioni flangia alluminio / Aluminium bracket dimension



Codice

Code

1723 RNF

TIPI DI INSTALLAZIONE INSTALLATION TYPES

1

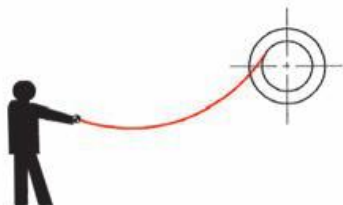

MANUAL USE

2

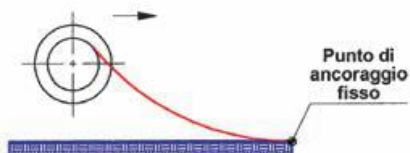

CABLE REEL ON MOBILE APPLICATION

3

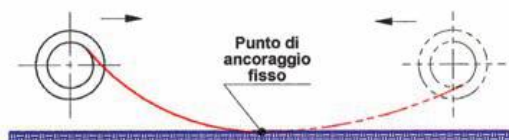

CABLE REEL ON MOBILE APPLICATION,
2 DIRECTION UNCOILING

7

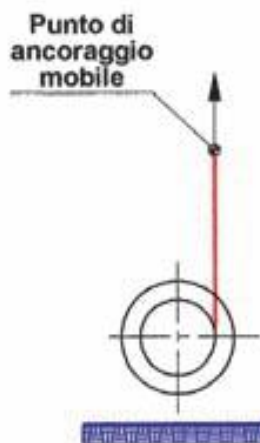

VERTICAL UNCOILING

Velocità massima di riavvolgimento

Max reeling speed

30 Mt / min



Codice

1703

Code

OPTIONALS

STAFFA FISSA

Per fissaggio a parete, pavimento o soffitto. Verificare la possibilità di installazione

FIXED BRACKET

For wall, floor or ceiling fastening
Check the models on which the optional bracket can be installed

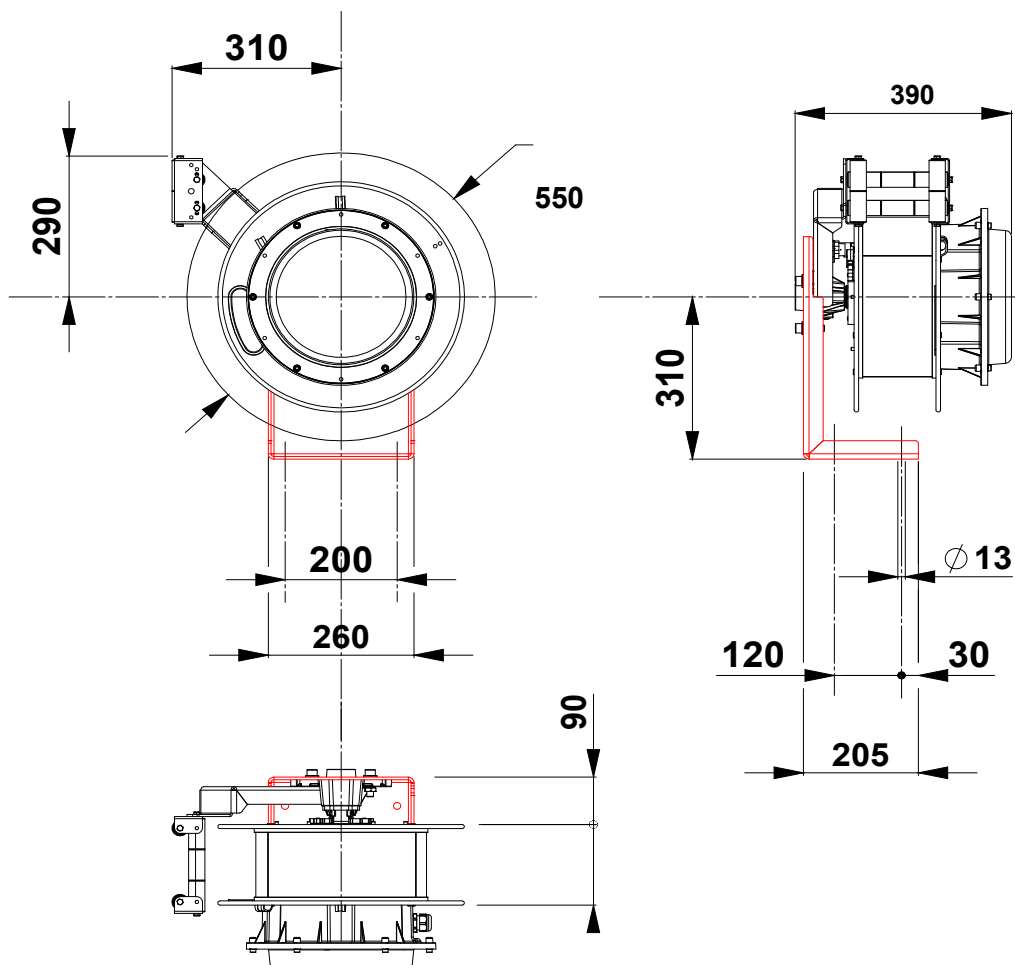
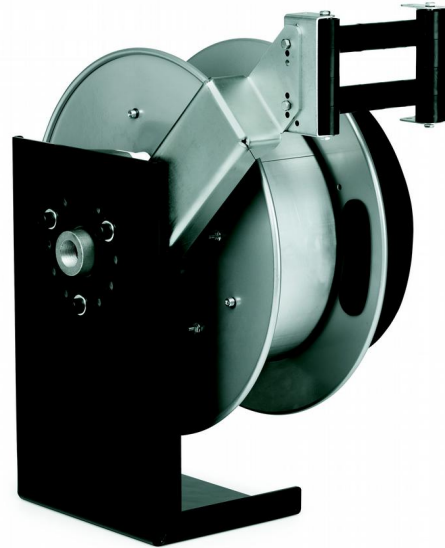



Codice

1704

Code

OPTIONALS

BRACCIO OSCILLANTE

Per installazioni con alimentazione a centro corsa. Non è possibile l'applicazione dell'art 1704 in abbinamento con altri optional.

Non installabile in un secondo momento.

SWIVELLING ARM

For installation with middle travel feeding. Impossible to install the swivelling arm with other optionals. **It is possible to install this optional only during the assembly of the cable reel, so this part cannot be bought separately**

