

General features

- Painted aluminum and steel case.
- Side fastening aluminum bracket.
- Steel springs suitable to allow optimum cable traction and long life.
- Protection degree IP 65 (cable versions only).
- Equipped with cable fastening socks (cable versions only).
- Delivered with 2,5 m. incoming cable
- Working temperature: $-5^\circ\text{C}/+50^\circ\text{C}$.
- Max recoiling speed: 30 m/min.
- Collector insulating power: 2,5 kV.
- Compliant to 2014/35/UE - 2006/42/CE
- Manufacturer compliance to EN60335-1 - EN61242 - EN61316

CABLE REEL SHEET

Number of conductors	24
Section (mm ²)	1,5
Cable length (m)	38+2
Cable type	CF130.15.25.UL
Cable diameter (mm)	19,5
Cable weight (g/m)	620
Single conductor maximum power (A)	4,5
Slipping capacity (A)	16
Cable-reel weight (kg)	-

REEL INSTALLATION METHODS

1

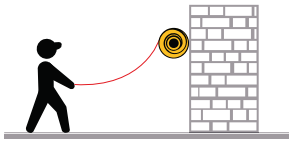

Manual use

2

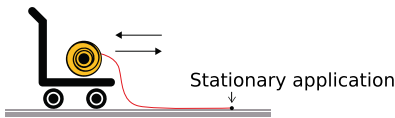

Cable reel on mobile application, 2 dir. uncoiling

3

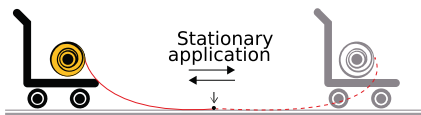

Cable reel on mobile application, 2 dir. uncoiling

4

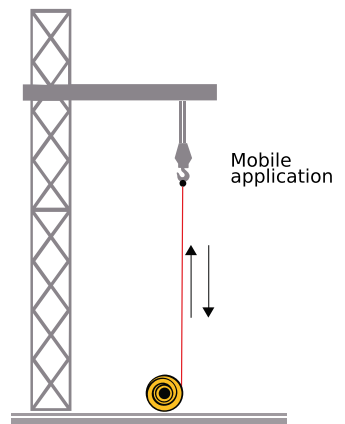

Mobile application

Vertical uncoiling

ART.945 - FUNNEL-SHAPED CABLE GUIDE OUTLET

Cable guide outlet with structure made of steel sheet, with two series of rollers made of shock-resistant plastic material allowing to unwind the cable in two directions without causing excessive bending angles, and improving the performance of the cable

ART. 945 - Funnel-shaped cable guide outlet.

DIMENSIONS

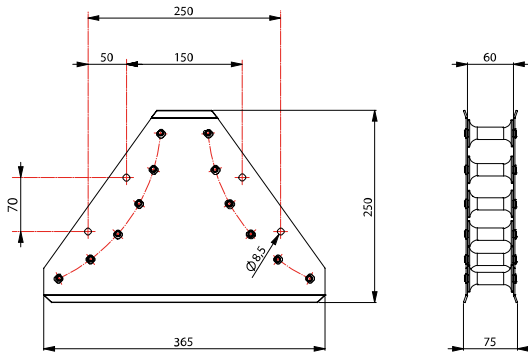

ART.951-954-955-957 - ROLLER CABLE GUIDE OUTLET

Cable guide outlet with structure made of galvanized steel sheet and nylon rollers. By repositioning the rollers it allows to get different dimensions of cable outlet.

ART	A	B	C
951		125	55
954	15-25-35-45-55	185	115
955		215	145



ART. 951-954-955



ART. 957

DIMENSIONS

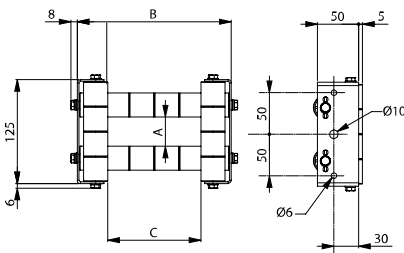

DIMENSIONS

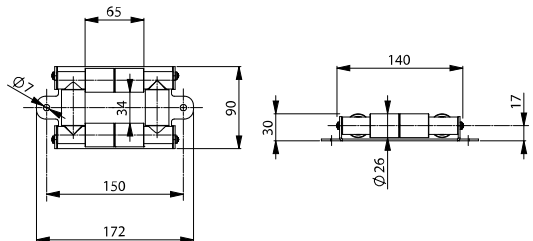

CABLE-FASTENING SOCKS

The cable fastening socks are manufactured in galvanized steel and are useful for fastening the the cable at its end without damaging the internal conductors, this avoiding curling and fast wearing of the cable.

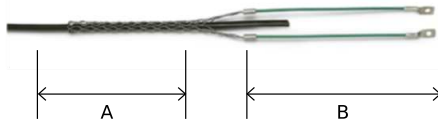
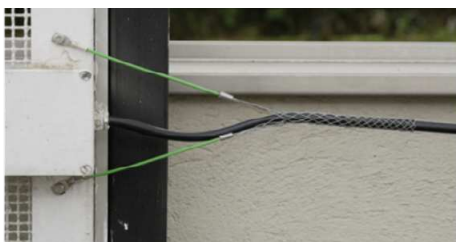

ART	CABLE EXT. Ø	A	B
949/10	8-10	165	130
949/12	10-13	165	130
949/14	15-18	140	200
949/15	12-16	130	165
949/17	18-22	200	140
949/20	22-28	200	195

Supplied as standard on full-cable 1700 series.

ART. 956 - FRICTION SPRING

If discontinuous and high tractive efforts are expected, we suggest inserting a friction spring between the cable-fastening sock and the anchorage point.

ART. 956 - Friction spring.



ART. 932 - CABLE GUIDE ROLLER WITH BRACKET

Cable guide roller made of shock-resistant plastic material with bracket of galvanized steel sheet.

ART. 932 - Cable guide roller with bracket.

DIMENSIONS

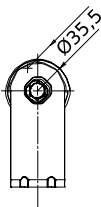
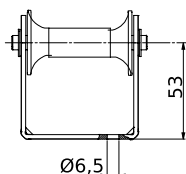
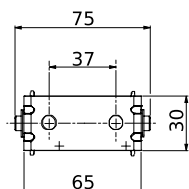







CF130.15.25.UL



Multi-core cable for flexing applications

Minimum bending radius: 7,5 x Outer Ø

 Conductors	 Section (mm ²)	 Outer Ø (mm)	 Weight (g/m)	 Core insulation	 Outerjacket Colour	
24	1,5	19,5	620	TPE	PVC	GREY

Voltage rating (V): 300/500

Test Voltage (V): 2.000 (compliance to DIN EN 50395)

Temperature Rating (°C): +70

Construction: compliant to EN 50525-2-21

Flame retardant: according to IEC 60332-1-2; CEI 20-35, VW-1, FT-1